

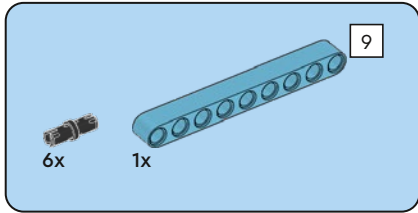

45820

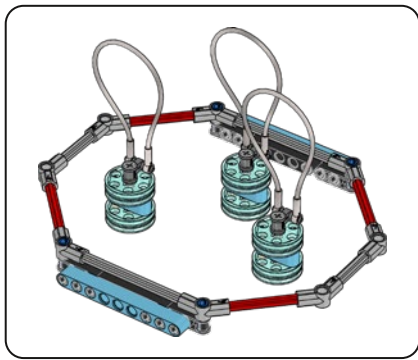

1

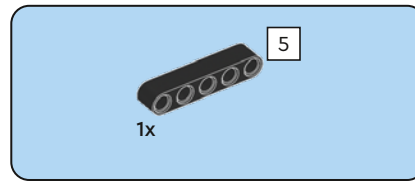
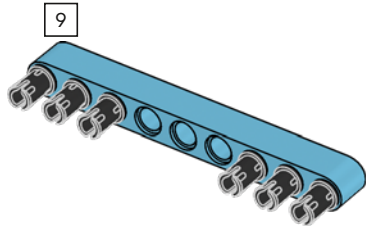

2

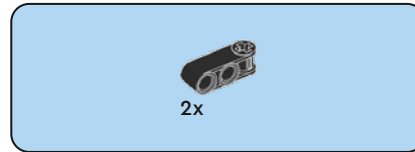
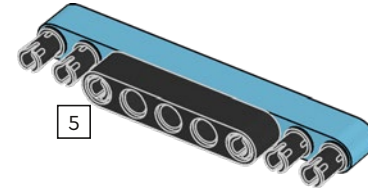

3

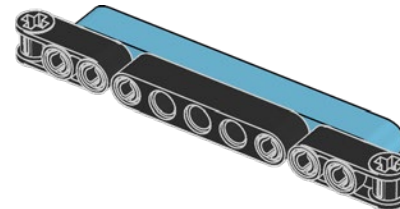

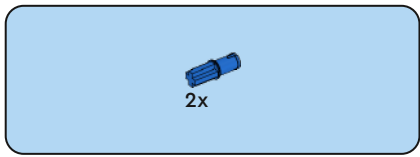

4

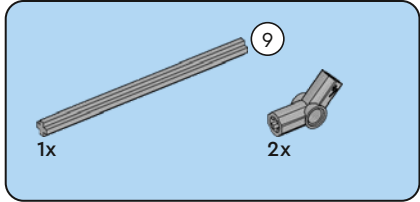
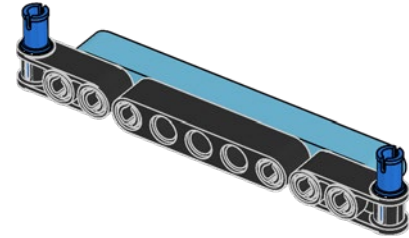

5

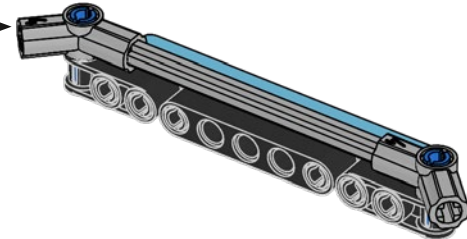
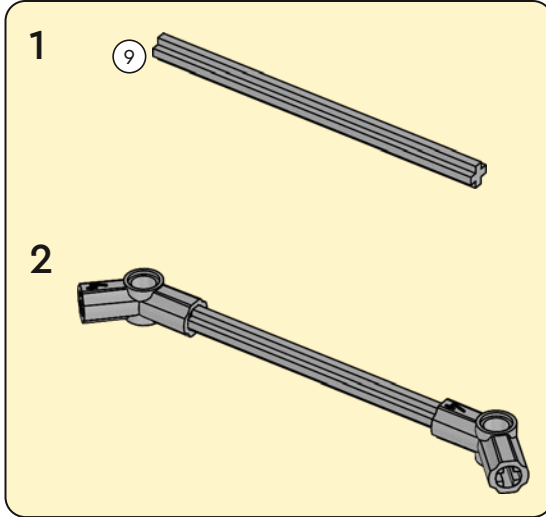

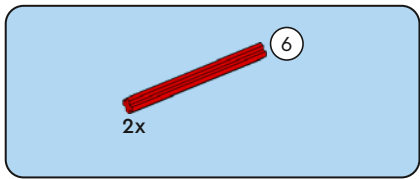

6

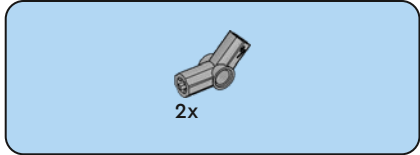
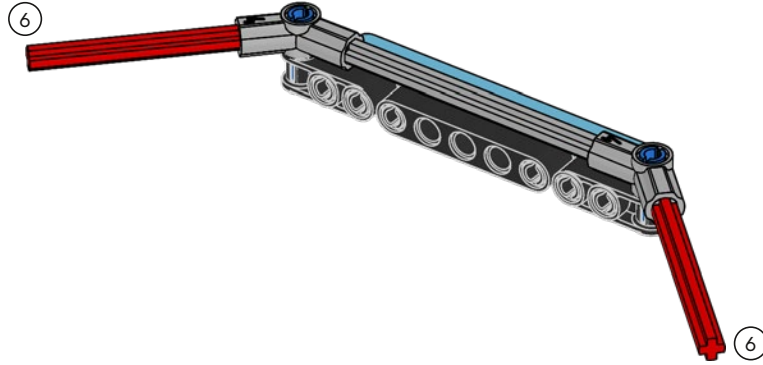

7

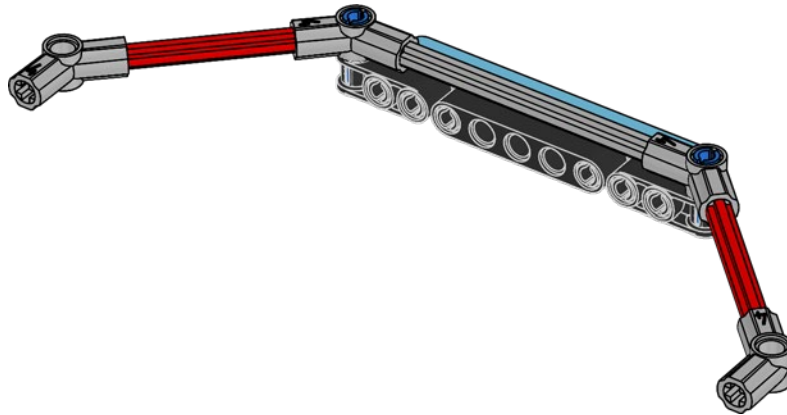

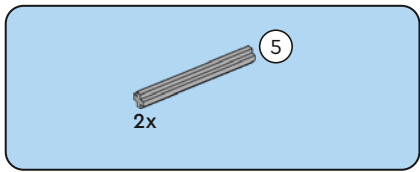

8

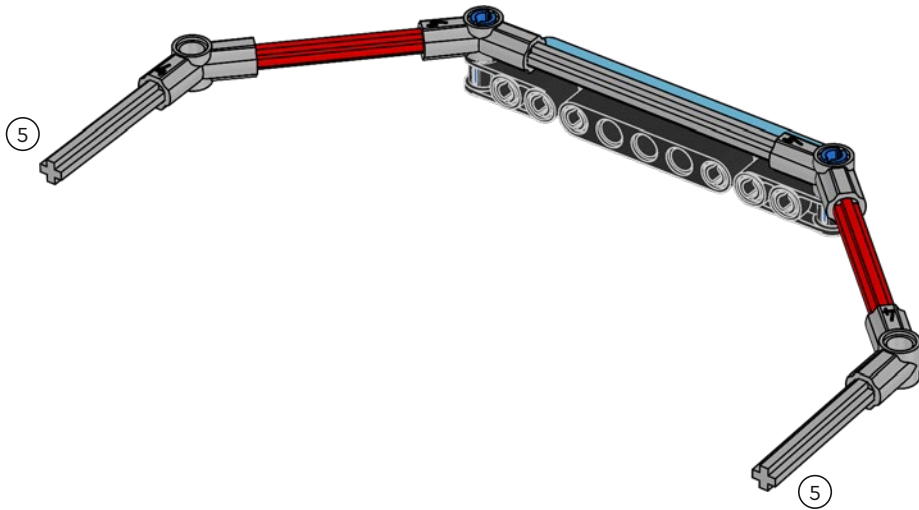

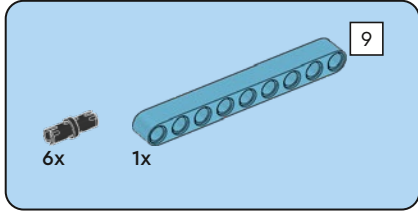
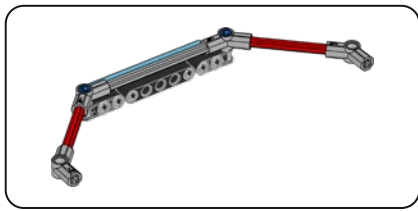

9

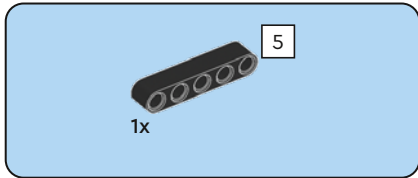
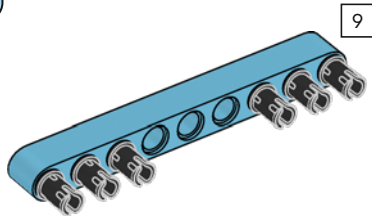

10

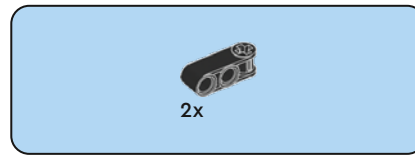
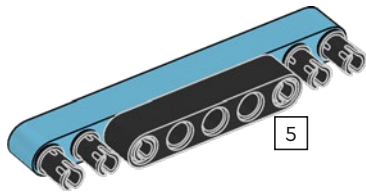

11

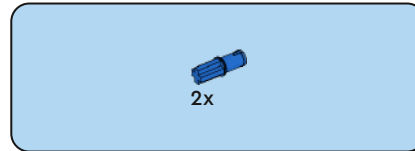
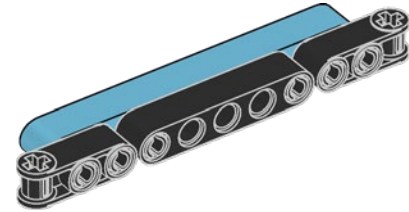

12

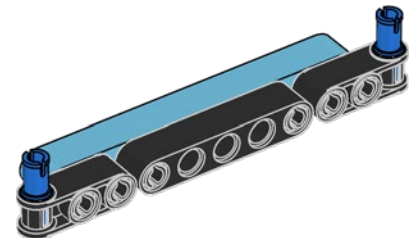

12

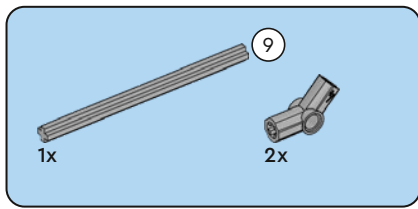

13

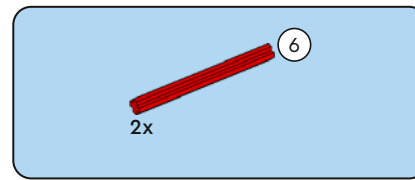
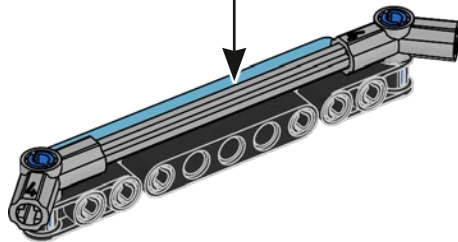
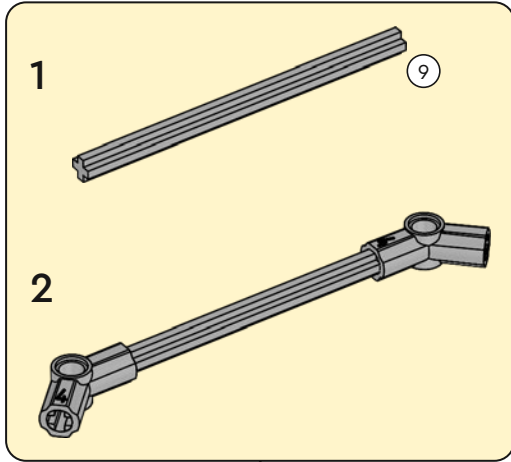

14

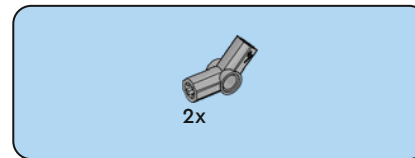
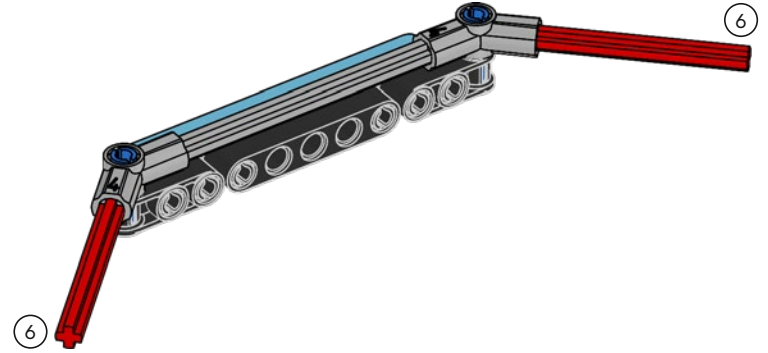

15

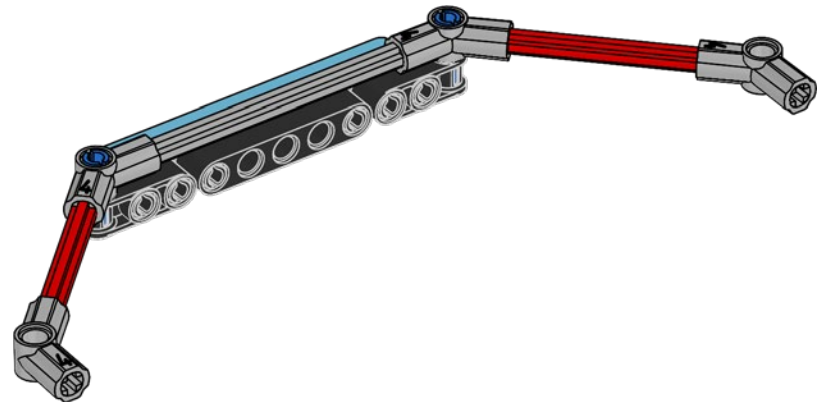

16

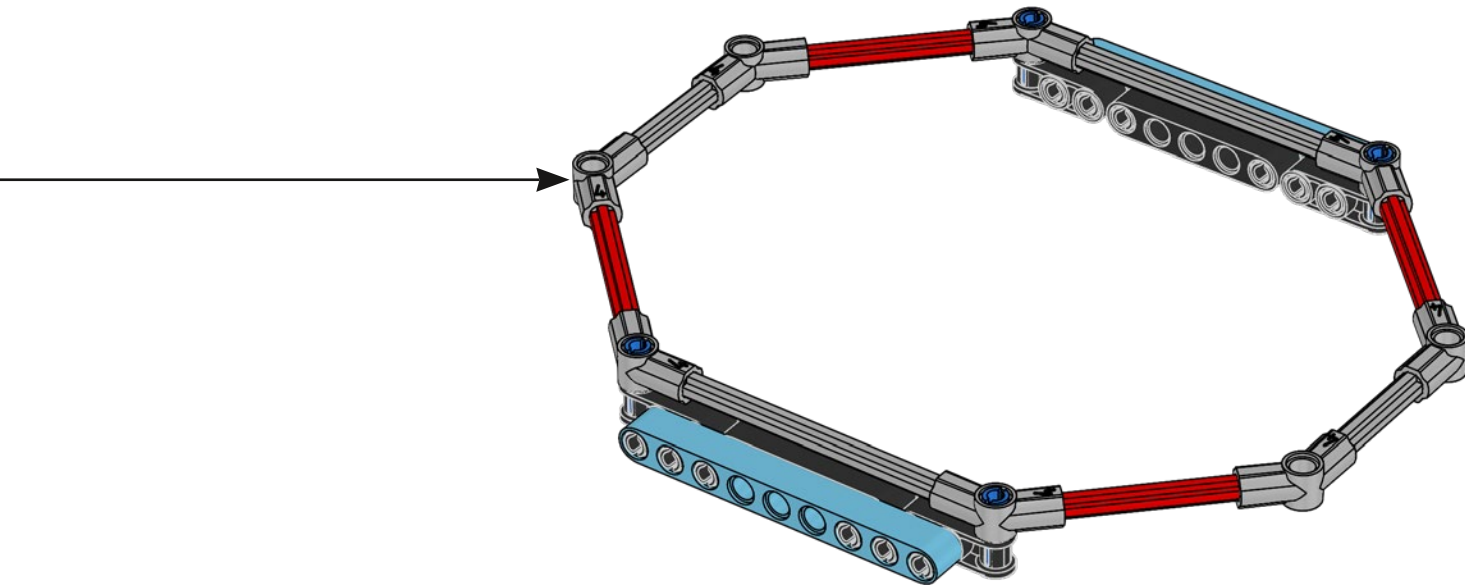



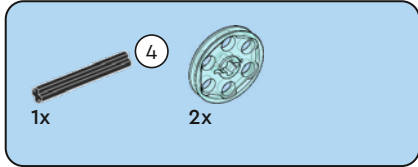
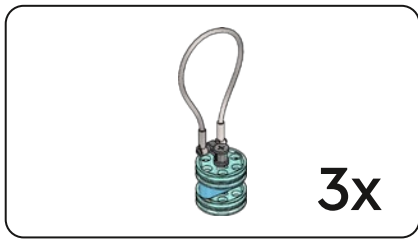

17

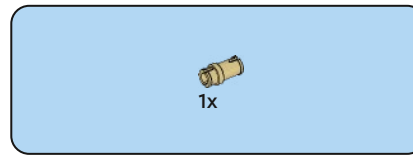
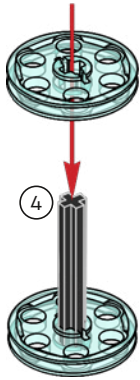

18

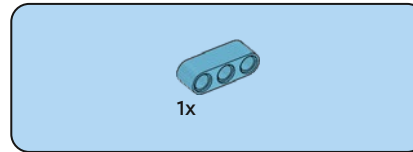
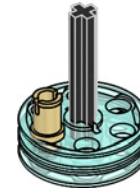

19

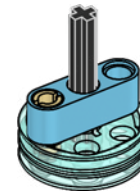

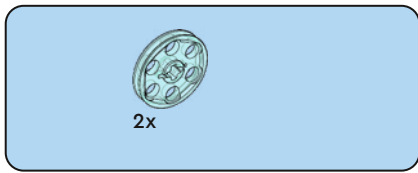

20

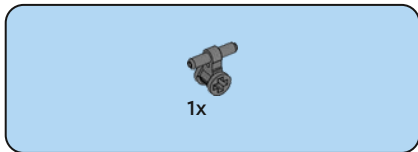
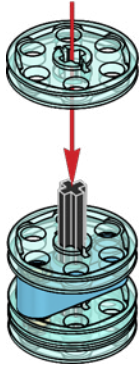

21

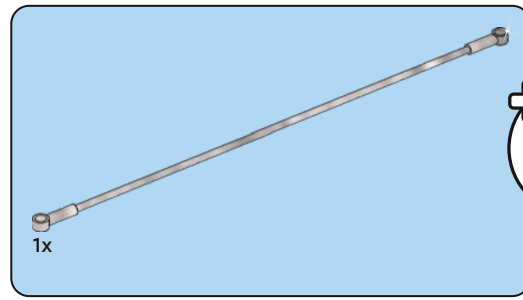
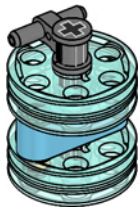

22



12

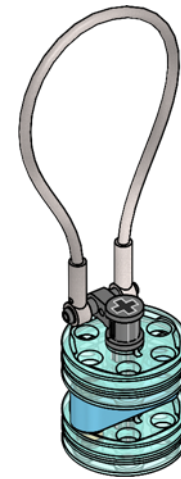

3x

23

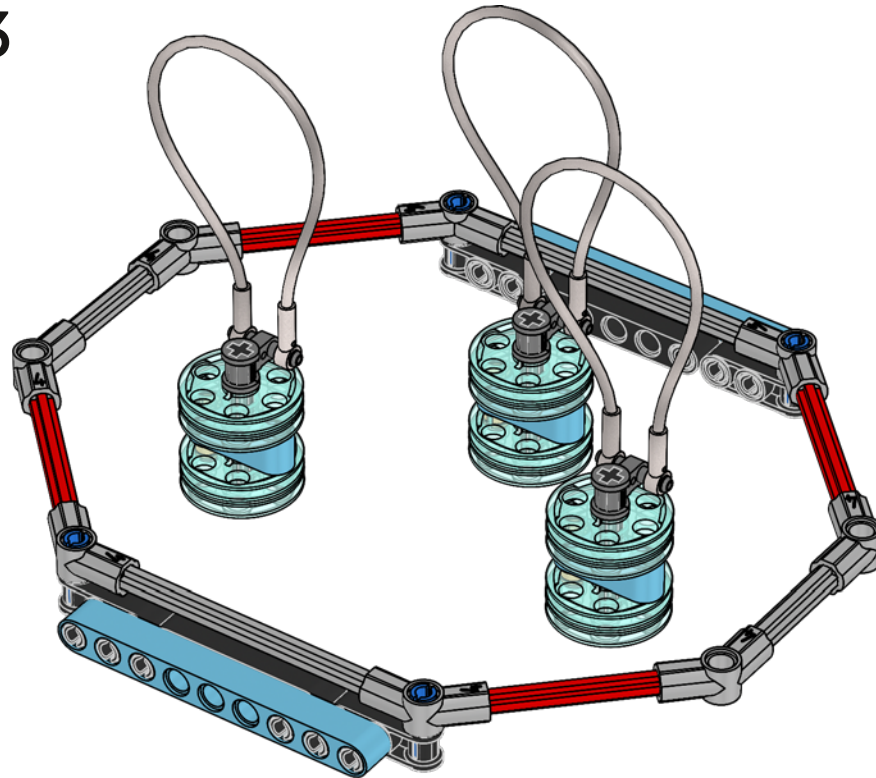

LEGO and the LEGO logo are trademarks of the/sont des marques de commerce du/son marcas registradas de LEGO Group. ©2022 The LEGO Group.

FIRST™ is a registered trademark of For Inspiration and Recognition of Science and Technology (FIRST). LEGO® is a registered trademark of the LEGO Group. FIRST™ LEGO® League and SUPERPOWERED™ are jointly held trademarks of FIRST and the LEGO Group.

©2022 FIRST and the LEGO Group. All rights reserved.